

# InterActive™

Implants | Prosthetics | Instruments



# TABLE OF CONTENTS

## IMPLANTS

---

	PAGE
All-in-1 Packaging Implants	2-3
Mount-Free Implants	4-5
Implant Dimensions	6

## PROSTHETICS

---

Cover Screws, Healing Collars & Transfers	8
Analogs, Scan Adapters & Temporary Abutments	9
simply <b>crow</b> n & <b>bridge</b> SMART PACK, Abutments & Ancillary Components	10
Fixture-Mounts & Straight Contoured Abutments	11
Angled Contoured, Gold Engaging & Non-Engaging Abutments, Screws	12
SMARTbase Titanium Abutments, Ancillary Components & Off Axis Tools	13
simply <b>fixed</b> SMART PACK, Ball Abutments & Components	14
LOCATOR® Abutments & Components	15-16
Multi-Unit Abutments & Components	17-18

## INSTRUMENTS

---

Surgical Trays & Prosthetic Instruments	20-21
Surgical Drills	22
Drill Sequence	23
Surgical Trays	24-25

# INTERACTIVE IMPLANTS

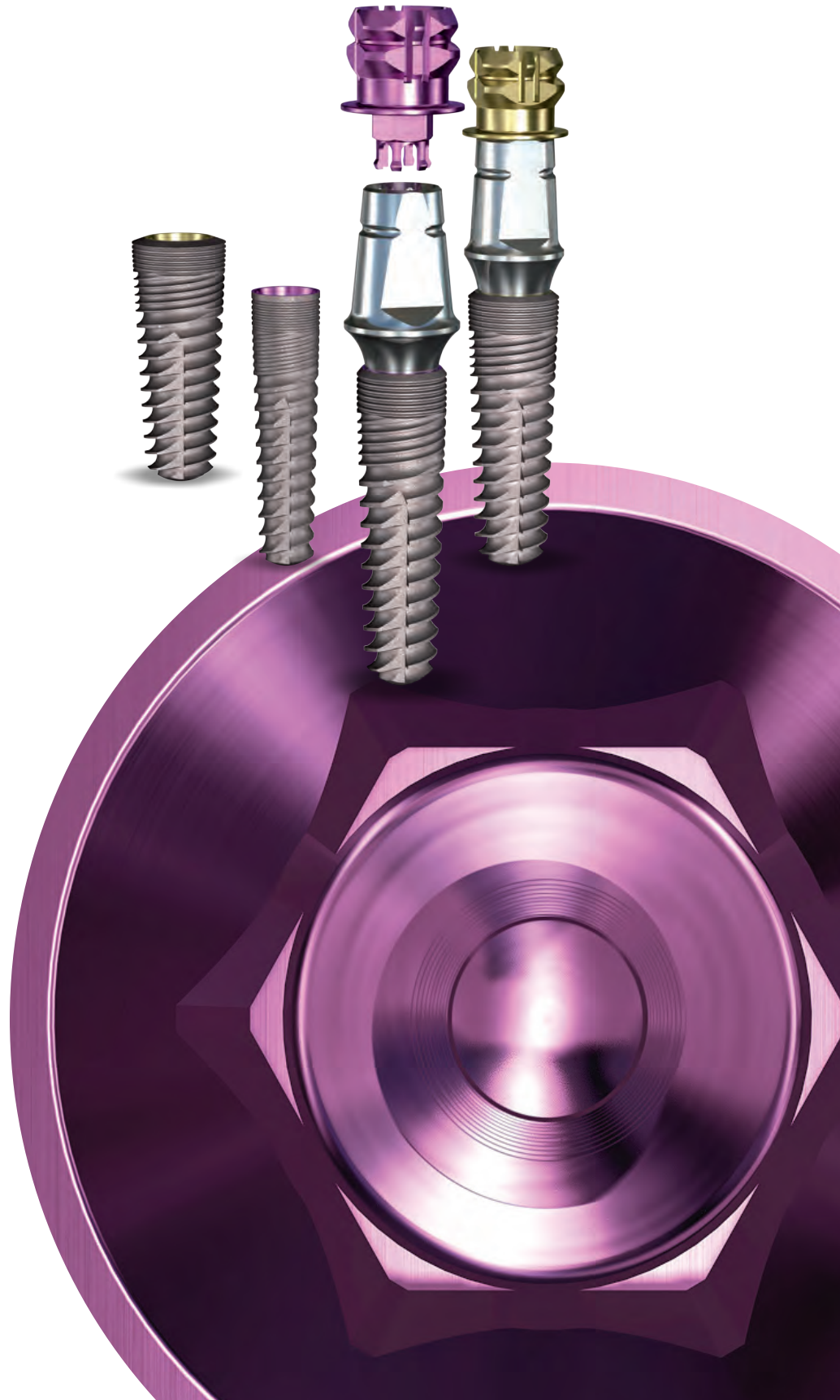

All-in-1 Packaging Implants  
InterActive™

Mount-Free Implants  
simplyInterActive

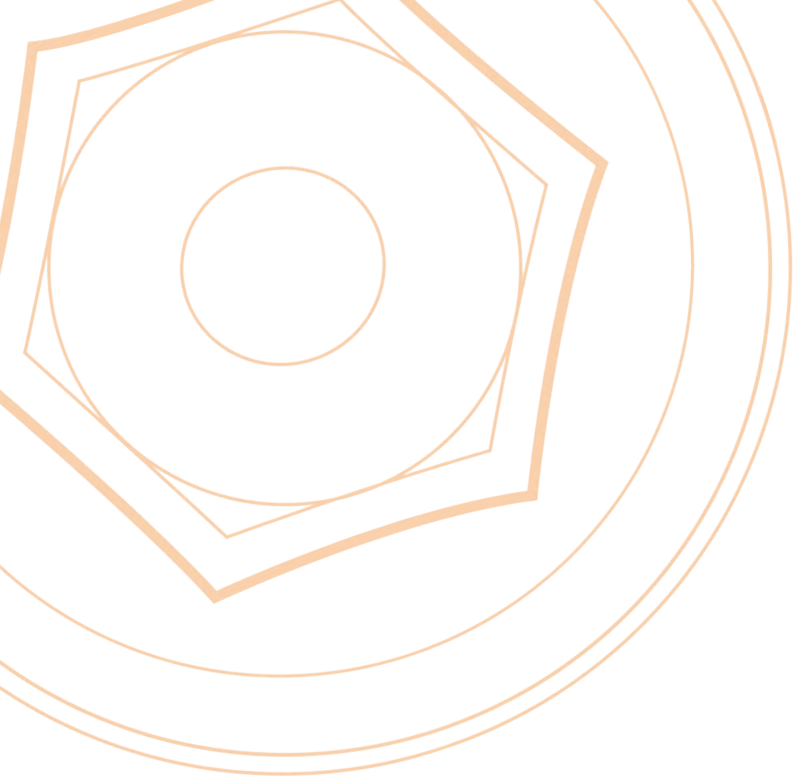

# InterActive™ IMPLANT SYSTEM

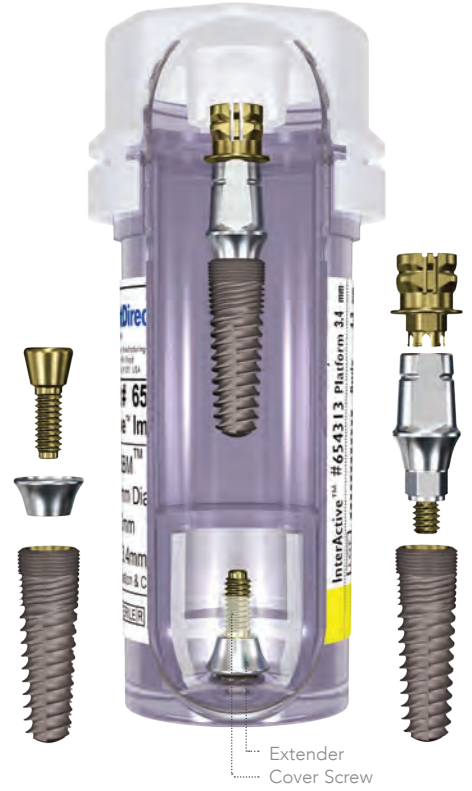

•3.0mmD  
Platform



•3.0mmD  
Platform



•3.4mmD  
Platform



•3.4mmD  
Platform



3.2mmD  
Implant



3.7mmD  
Implant



4.3mmD  
Implant



5.0mmD  
Implant



## Insertion & Impression Technique







## INTERACTIVE™ IMPLANT SYSTEM

### SBM SURFACE IMPLANTS

Straight/tapered implant body with progressively-deeper buttress threads and three cutting grooves.

Includes: Cover screw, healing collar extender & 2-piece metal-to-metal, closed-tray transfer.  
Extender not supplied with 6.0mmL implant.



	Diameter	Platform	Surface	6.0mmL*	8.0mmL	10.0mmL	11.5mmL	13.0mmL	16.0mmL
	3.2mmD	3.0mmD	SBM	-	653208	653210	653211	653213	653216
	3.7mmD	3.0mmD	SBM	653706	653708	653710	653711	653713	653716
	4.3mmD	3.4mmD	SBM	654306	654308	654310	654311	654313	654316
	5.0mmD	3.4mmD	SBM	655006	655008	655010	655011	655013	655016

\*Extender NOT supplied with 6.0mmL implant

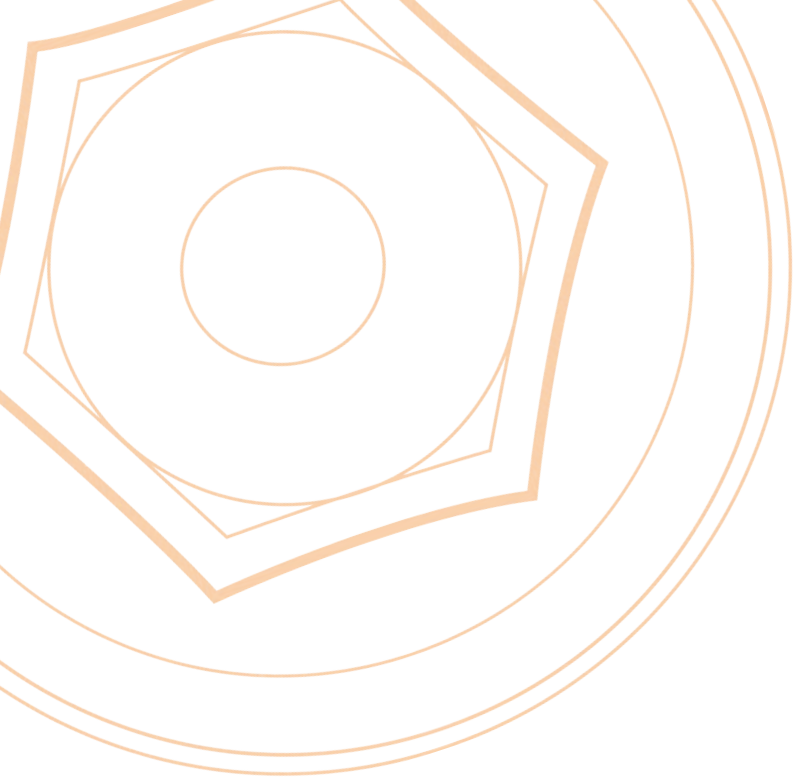

# simplyInterActive™ MOUNT-FREE IMPLANTS

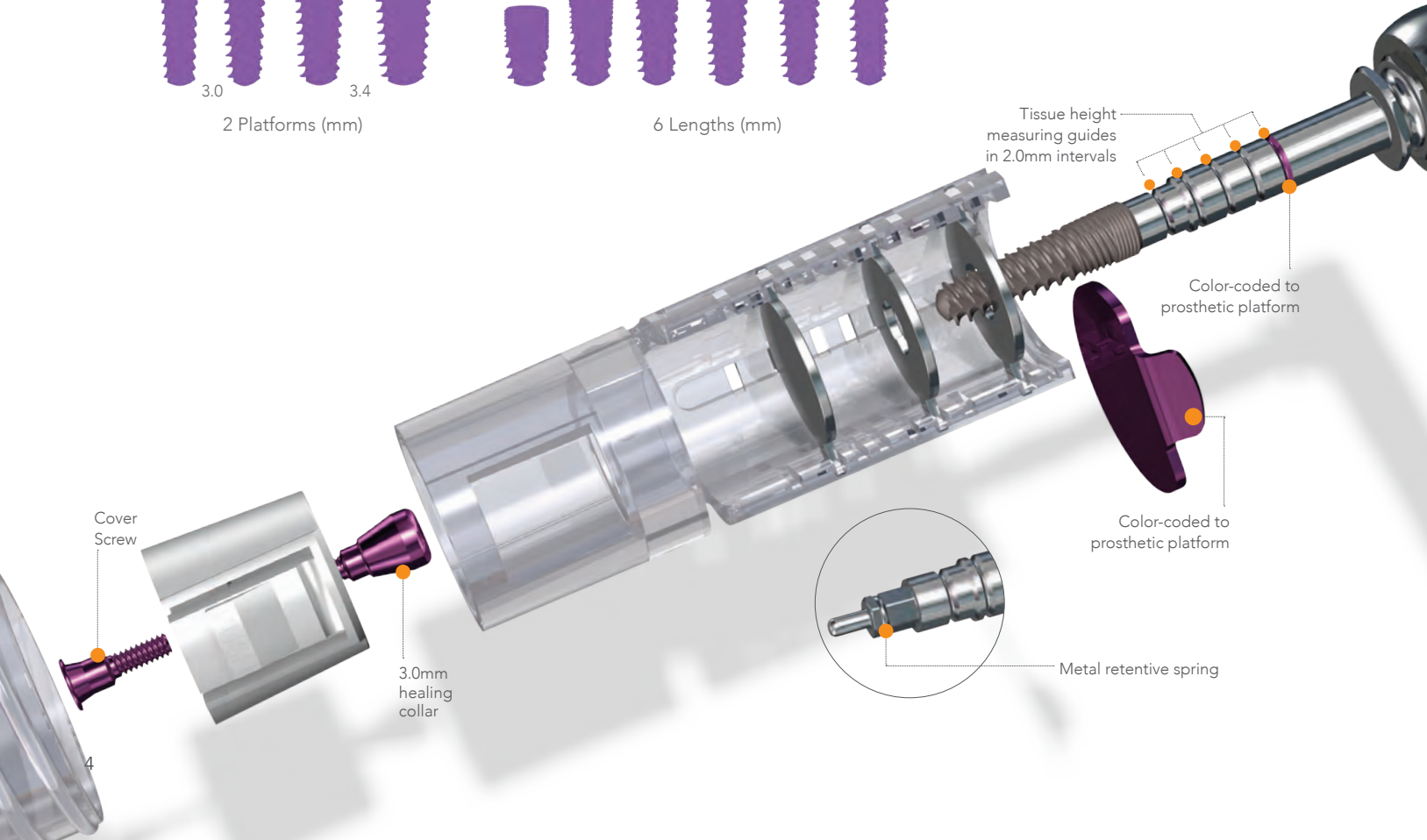
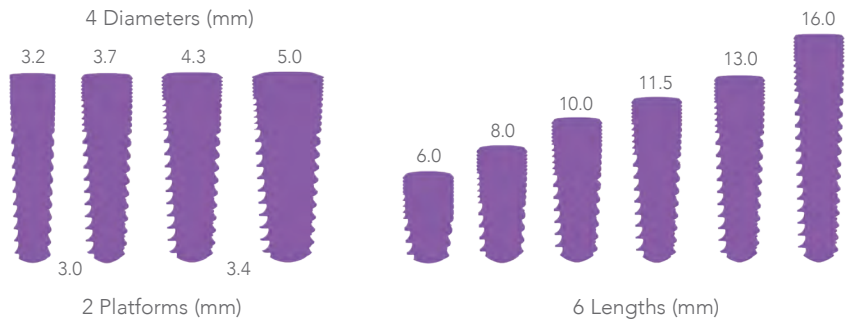

MOUNT-FREE IMPLANTS

simplyInterActive

Diameter	Platform	6.0mmL	8.0mmL	10.0mmL	11.5mmL	13.0mmL	16.0mmL
3.2mmD	3.0mmD	-	653208U	653210U	653211U	653213U	653216U
3.7mmD	3.0mmD	653706U	653708U	653710U	653711U	653713U	653716U
4.3mmD	3.4mmD	654306U	654308U	654310U	654311U	654313U	654316U
5.0mmD	3.4mmD	655006U	655008U	655010U	655011U	655013U	655016U



SMART PACKS

Please turn to page 10 & 14 for SMART PACK details



simplyfixed



simplycrown & bridge

simplyInterActive

DRIVERS

simplyInterActive drivers are highly recommended for simplyInterActive implants

Code	Platform(s) Used With	Type	Length
HD2.3SG	● 3.0mmD	Handpiece	25.5mm
HT2.3SG	● 3.0mmD	Wrench	18.5mm
HT2.3LG	● 3.0mmD	Wrench	30.0mm
HD2.7SG	● 3.4mmD	Handpiece	25.5mm
HT2.7SG	● 3.4mmD	Wrench	18.5mm
HT2.7LG	● 3.4mmD	Wrench	30.0mm

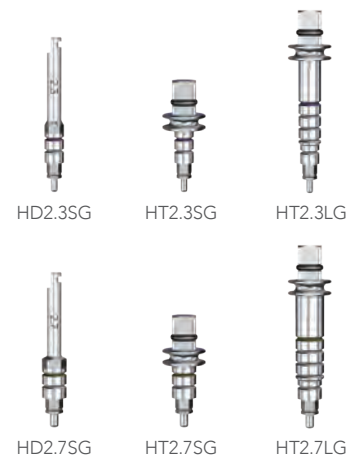

**INTERACTIVE**

**IMPLANT DIMENSIONS**

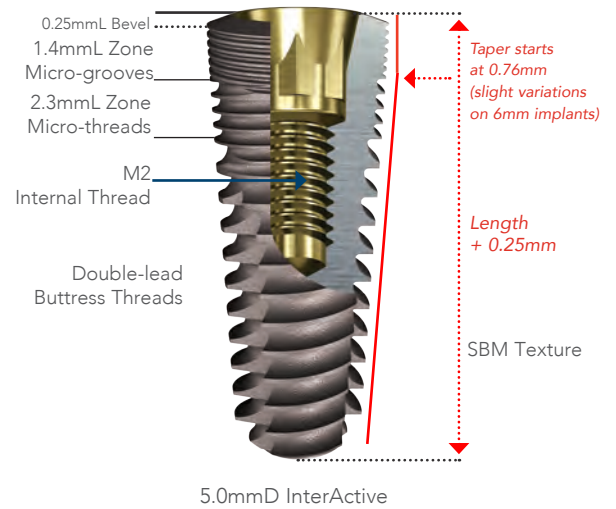
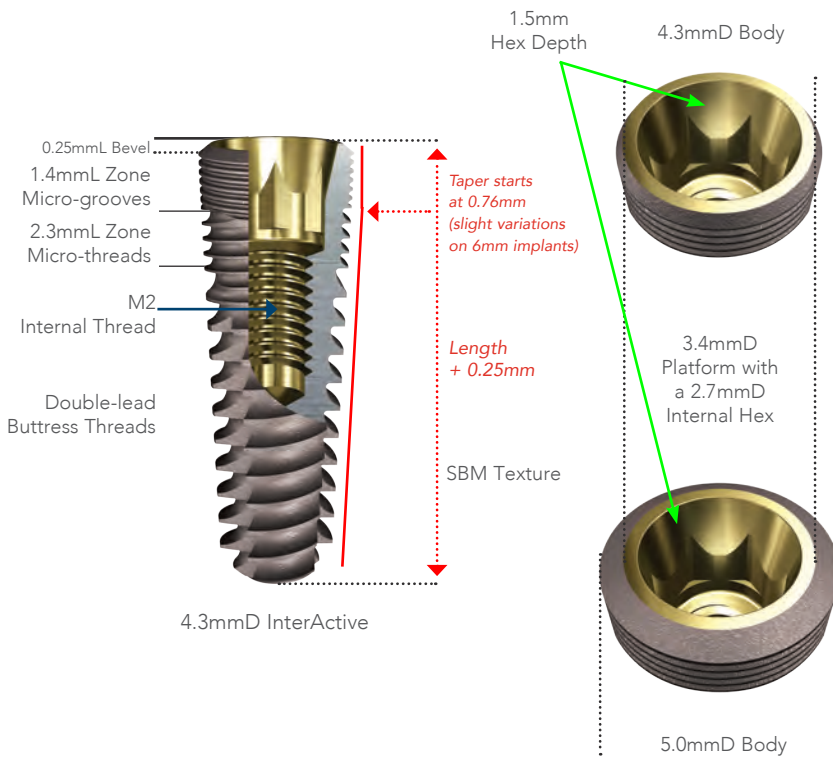
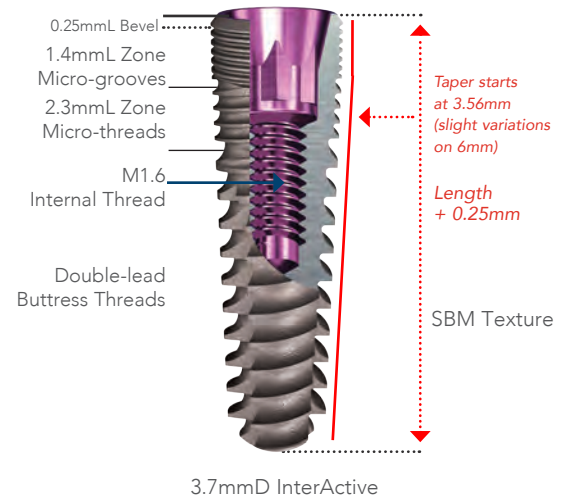
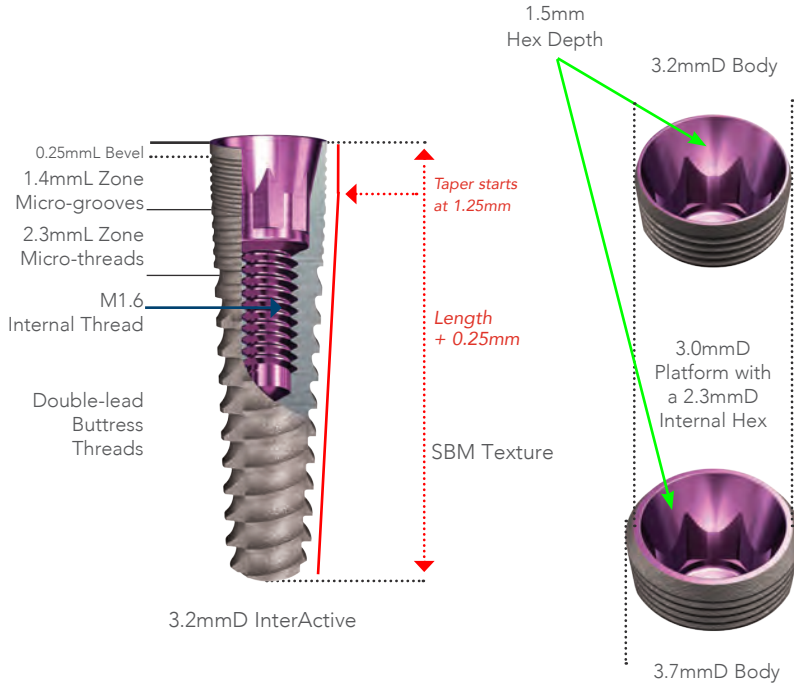



# INTERACTIVE PROSTHETICS



Transfers & Analogs

Temporary Abutments

Final Abutments

Overdenture &  
Multi-Unit  
Abutments

# COVER SCREWS, HEALING COLLARS & TRANSFERS

## Replacement Surgical Cover Screws Requires 1.25mmD Hex Tool

Code	Platform	<small>[*for 6.0mm or simplyInterActive only]</small>
6530-01	● 3.0mmD	
*6530-01S	● 3.0mmD	
6534-01	● 3.4mmD	
*6534-01S	● 3.4mmD	



## Narrow Healing Collars Requires 1.25mmD Hex Tool

Code	Platform	Width	Length
6530-13N	● 3.0mmD	3.8mmD	3.0mmL
6530-15N	● 3.0mmD	3.8mmD	5.0mmL
6534-13N	● 3.4mmD	5.0mmD	3.0mmL
6534-15N	● 3.4mmD	5.0mmD	5.0mmL



## Healing Collars Requires 1.25mmD Hex Tool

Code	Platform	Width	Length
6530-13	● 3.0mmD	5.0mmD	3.0mmL
6530-15	● 3.0mmD	5.0mmD	5.0mmL
6534-13	● 3.4mmD	5.8mmD	3.0mmL
6534-15	● 3.4mmD	5.8mmD	5.0mmL



## Wide Healing Collars Requires 1.25mmD Hex Tool

Code	Platform	Width	Length
6534-13W	● 3.4mmD	6.6mmD	3.0mmL
6534-15W	● 3.4mmD	6.6mmD	5.0mmL



## Closed-Tray Implant Transfers Includes Fixation Screw with 1.25mmD Hex

Code	Platform	Width	Replacement Screw (2 Pieces)
6530-05N	● 3.0mmD	3.8mmD	1000-36
6530-05	● 3.0mmD	5.0mmD	1000-36
6534-05N	● 3.4mmD	5.0mmD	1000-33
6534-05	● 3.4mmD	5.8mmD	1000-33
6534-05W	● 3.4mmD	6.6mmD	1000-33



## Open-Tray Implant Transfers Includes Fixation Screw with 1.25mmD Hex

Code	Platform	Width	Replacement Screw (2 Pieces)
6530-08N	● 3.0mmD	3.8mmD	1000-37
6530-08	● 3.0mmD	5.0mmD	1000-37
6534-08N	● 3.4mmD	5.0mmD	1000-35
6534-08	● 3.4mmD	5.8mmD	1000-35
6534-08W	● 3.4mmD	6.6mmD	1000-35



# ANALOGS, SCAN ADAPTERS & TEMPORARY ABUTMENTS

## Implant Analogs (3D Printed & Stone Models)

Code	Platform
6530-06D	● 3.0mmD
6534-06D	● 3.4mmD

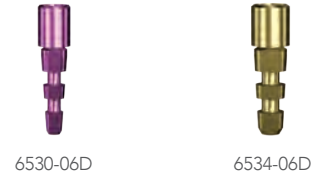

## PEEK/Titanium Scan Adapter Single-Use\*

Includes Fixation Screw (For use with Implant Direct design library)

Code	Platform	Replacement Screw
6530-09PT	● 3.0mmD	1000-34B
6534-09PT	● 3.4mmD	1000-32B



\*Multi-Use acceptable when used in Laboratory only.

## Replacement Fixation Screws 2 Pieces

Code	Platform
1000-34S1	● 3.0mmD
1000-34	● 3.0mmD
1000-36	● 3.0mmD
1000-37	● 3.0mmD
1000-54	● 3.0mmD
1000-32S1	● 3.4mmD
1000-32	● 3.4mmD
1000-33	● 3.4mmD
1000-35	● 3.4mmD
1000-52	● 3.4mmD

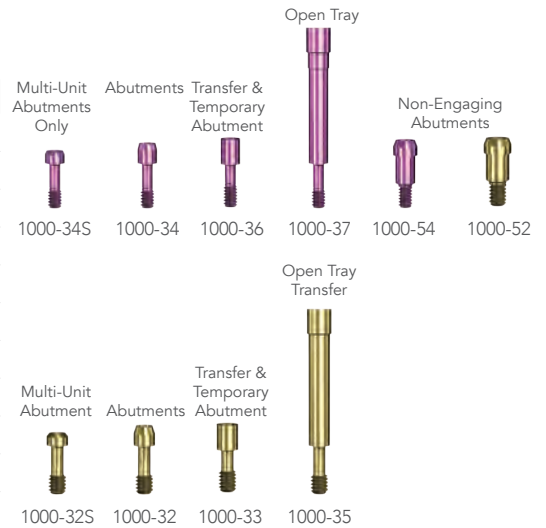

## Plastic Engaging Temporary Abutments Includes Fixation Screw with 1.25mmD Hex

Code	Collar Heights	Platform	Replacement Screw
6530-47N	-	● 3.0mmD	1000-36
6530-47	-	● 3.0mmD	1000-36
6534-47N	-	● 3.4mmD	1000-33
6534-47	-	● 3.4mmD	1000-33

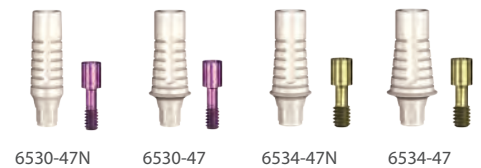

## Titanium Non-Engaging Temporary Abutments Includes Fixation Screw

Code	Collar Heights	Platform	Replacement Screw
6530-49	-	● 3.0mmD	1000-54
6534-49	-	● 3.4mmD	1000-52



# SIMPLYCROWN & BRIDGE SMART PACKS, STRAIGHT ABUTMENTS & ANCILLARY COMPONENTS



## simplycrown & bridge SMART PACK

Includes:  
 Straight Abutment with concave profile    Castable Coping  
 Transfer Analog                                    Comfort Cap  
 Analog    Fixation Screw

### simplycrown & bridge SMART PACKS-Concave Profile

Code	Platform	Abutment Width	Collar Heights	Replacement Screw
6530-21N	● 3.0mmD	3.7mmD	1.0mm	1000-34
6530-22N	● 3.0mmD	3.7mmD	2.0mm	1000-34
6530-23N	● 3.0mmD	3.7mmD	3.0mm	1000-34
6530-21	● 3.0mmD	4.7mmD	1.0mm	1000-34
6530-22	● 3.0mmD	4.7mmD	2.0mm	1000-34
6530-23	● 3.0mmD	4.7mmD	3.0mm	1000-34
6534-21N	● 3.4mmD	4.7mmD	1.0mm	1000-32
6534-22N	● 3.4mmD	4.7mmD	2.0mm	1000-32
6534-23N	● 3.4mmD	4.7mmD	3.0mm	1000-32
6534-21	● 3.4mmD	5.7mmD	1.0mm	1000-32
6534-22	● 3.4mmD	5.7mmD	2.0mm	1000-32
6534-23	● 3.4mmD	5.7mmD	3.0mm	1000-32
6534-21W	● 3.4mmD	6.5mmD	1.0mm	1000-32
6534-22W	● 3.4mmD	6.5mmD	2.0mm	1000-32
6534-23W	● 3.4mmD	6.5mmD	3.0mm	1000-32



### Straight Abutment Transfers <sup>2 Pieces</sup>

Code	Abutment Width
3037-02	3.7mmD
3047-02	4.7mmD
3057-02	5.7mmD
3065-02	6.5mmD



### Straight Abutment Comfort Caps <sup>2 Pieces</sup>

Code	Abutment Width
3037-26	3.7mmD
3047-26	4.7mmD
3057-26	5.7mmD
3065-26	6.5mmD



### Straight Abutment Analogs <sup>Includes Castable Coping</sup>

Code	Abutment Width
3037	3.7mmD
3047	4.7mmD
3057	5.7mmD
3065	6.5mmD



### Straight Abutment Castable Copings <sup>2 Pieces</sup>

Code	Abutment Width
3037-28	3.7mmD
3047-28	4.7mmD
3057-28	5.7mmD
3065-28	6.5mmD



# FIXTURE-MOUNTS & STRAIGHT CONTOURED ABUTMENTS

## Fixture-Mounts Includes Fixation Screw

Code	Platform	Collar Heights
6530-02N	● 3.0mmD	2.0mm
6530-02	● 3.0mmD	2.0mm
6534-02N	● 3.4mmD	2.0mm
6534-02	● 3.4mmD	2.0mm



## Fixture-Mount Analogs-Concave Profile

Code	Platform	Abutment Width
6530N	● 3.0mmD	3.7mmD
6530	● 3.0mmD	4.7mmD
6534N	● 3.4mmD	4.7mmD
6534	● 3.4mmD	5.7mmD



## Straight Titanium Contoured Abutments Includes Fixation Screw

Code	Platform	Collar Heights	Replacement Screw
6530-31N	● 3.0mmD	1.0mm	1000-34
6530-32N	● 3.0mmD	2.0mm	1000-34
6530-33N	● 3.0mmD	3.0mm	1000-34
6530-31	● 3.0mmD	1.0mm	1000-34
6530-32	● 3.0mmD	2.0mm	1000-34
6530-33	● 3.0mmD	3.0mm	1000-34
6534-31N	● 3.4mmD	1.0mm	1000-32
6534-32N	● 3.4mmD	2.0mm	1000-32
6534-33N	● 3.4mmD	3.0mm	1000-32
6534-31	● 3.4mmD	1.0mm	1000-32
6534-32	● 3.4mmD	2.0mm	1000-32
6534-33	● 3.4mmD	3.0mm	1000-32



# ANGLED CONTOURED, GOLD ENGAGING & NON-ENGAGING ABUTMENTS, SCREWS

## 15° Angled Titanium Contoured Abutments Includes Fixation Screw

Code	Collar Heights	Platform	Replacement Screw
6530-51N	0.75mm	● 3.0mmD	1000-34
6530-52N	2.0mm	● 3.0mmD	1000-34
6530-53N	3.0mm	● 3.0mmD	1000-34
6530-51	0.75mm	● 3.0mmD	1000-34
6530-52	2.0mm	● 3.0mmD	1000-34
6530-53	3.0mm	● 3.0mmD	1000-34
6534-51N	0.75mm	● 3.4mmD	1000-32
6534-52N	2.0mm	● 3.4mmD	1000-32
6534-53N	3.0mm	● 3.4mmD	1000-32
6534-51	0.75mm	● 3.4mmD	1000-32
6534-52	2.0mm	● 3.4mmD	1000-32
6534-53	3.0mm	● 3.4mmD	1000-32



## Gold Engaging Cast-to Abutments Includes Fixation Screw

Code	Collar Heights	Platform	Replacement Screw
6530-40N	1.0mm	● 3.0mmD	1000-34
6530-40	1.0mm	● 3.0mmD	1000-34
6534-40N	1.0mm	● 3.4mmD	1000-32
6534-40	1.0mm	● 3.4mmD	1000-32



## Gold Non-Engaging Cast-to Abutments Includes Fixation Screw

Code	Collar Heights	Platform	Replacement Screw
6530-41	1.0mm	● 3.0mmD	1000-54
6534-41	1.0mm	● 3.4mmD	1000-52



## Tri-Grip™ Fixation Screw

Code	Platform	Length
1000-34B	3.0mmD	7.4mmL
1000-32B	3.4mmD	7.7mmL
1000-54B	3.0mmD	7.4mmL
1000-52B	3.4mmD	7.7mmL

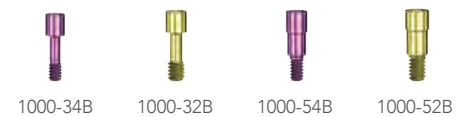

# SMARTBASE TITANIUM ABUTMENTS, ANCILLARY COMPONENTS & OFF AXIS TOOLS

## Engaging Dual Hue Titanium Base Includes Fixation Screw and Coping

Code	Platform	Collar Height	Width	Replacement Screw
6530-81N	3.0mmD	1.0mm	3.8mmD	1000-34B
6530-82N	3.0mmD	2.0mm	3.8mmD	1000-34B
6530-81	3.0mmD	1.0mm	4.7mmD	1000-34B
6530-82	3.0mmD	2.0mm	4.7mmD	1000-34B
6534-81XN	3.4mmD	1.0mm	4.4mmD	1000-32B
6534-82XN	3.4mmD	2.0mm	4.4mmD	1000-32B
6534-81N	3.4mmD	1.0mm	4.8mmD	1000-32B
6534-82N	3.4mmD	2.0mm	4.8mmD	1000-32B
6534-82	3.4mmD	2.0mm	5.7mmD	1000-32B
6534-82W	3.4mmD	2.0mm	6.3mmD	1000-32B

### Digital & Conventional Use



## Non-Engaging Dual Hue Titanium Base Includes Fixation Screw and Coping

Code	Platform	Collar Height	Width	Replacement Screw
6530-81NNE	3.0mmD	1.0mm	3.8mmD	1000-54B
6530-82NNE	3.0mmD	2.0mm	3.8mmD	1000-54B
6530-81NE	3.0mmD	1.0mm	4.7mmD	1000-54B
6530-82NE	3.0mmD	2.0mm	4.7mmD	1000-54B
6534-81-XNNE	3.4mmD	1.0mm	4.4mmD	1000-52B
6534-82-XNNE	3.4mmD	2.0mm	4.4mmD	1000-52B
6534-81NNE	3.4mmD	1.0mm	4.8mmD	1000-52B
6534-82NNE	3.4mmD	2.0mm	4.8mmD	1000-52B
6534-82NE	3.4mmD	2.0mm	5.7mmD	1000-52B
6534-82WNE	3.4mmD	2.0mm	6.3mmD	1000-52B

### Digital & Conventional Use



## Plastic Sleeve Burn Out Coping

Code	Length	Width
1000-38-28B	9.0mm	3.8mmD
1000-44-28B	9.0mm	4.4mmD
1000-47-28B	9.0mm	4.7mmD
1000-48-28B	9.0mm	4.8mmD
1000-57-28B	9.0mm	5.7mmD
1000-65-28B	9.0mm	6.5mmD

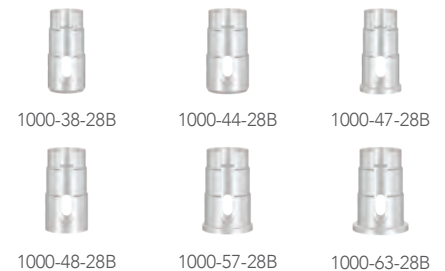

## Off-Axis Tools

Code	Description
HT1.3SB	Short Off-Axis Driver
HT1.3B	Off-Axis Driver
HT1.3LB	Long Off-Axis Driver
HD1.3B	Off-Axis Handpiece Tool
DAP	Off-Axis Driver Access Plug

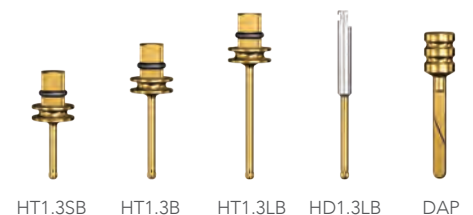

## SIMPLYFIXED SMART PACKS, BALL ABUTMENTS & COMPONENTS

### Ball Abutments Includes Transfer & Comfort Cap [Requires 1.25mmD Hex Tool]

Code	Collar Heights	Platform
6530-71	1.0mm	● 3.0mmD
6530-72	2.0mm	● 3.0mmD
6530-73	3.0mm	● 3.0mmD
6530-74	4.0mm	● 3.0mmD
6530-75	5.0mm	● 3.0mmD
6534-71N	1.0mm	● 3.4mmD
6534-72N	2.0mm	● 3.4mmD
6534-73N	3.0mm	● 3.4mmD
6534-74N	4.0mm	● 3.4mmD
6534-75N	5.0mm	● 3.4mmD



### Ball Abutment Components

Code	Description
1000-81	Ball Abutment Housing - 2 Pieces
1000-82	Nylon Liner - 2 Pieces
1000-83	Nylon Liner Transfer - 2 Pieces
1000-84	Ball Abutment Transfer - 2 Pieces
1000-85	Ball Abutment Analog - 1 Piece
1000-86	Ball Abutment Tools - 1 Piece
1000-87	Ball Abutment Comfort Cap - 2 Pieces
1000-88	Ball Abutment Housing & Nylon Liner



### simplyfixed SMART PACKS

Includes Multi-Unit Abutment, Abutment Analog, Transfer, Titanium Temporary Abutment, Comfort Cap, Fixation Screw

Code	Collar Heights	Platform	Angle
6530-62K	2.0mm	● 3.0mmD	0°
6530-63K	3.0mm	● 3.0mmD	0°
6530-62-15SK	2.5mm	● 3.0mmD	15°
6530-63-15SK	3.5mm	● 3.0mmD	15°
6530-63-30SK	3.5mm	● 3.0mmD	30°
6534-62K	2.0mm	● 3.4mmD	0°
6534-63K	3.0mm	● 3.4mmD	0°
6534-62-15SK	2.5mm	● 3.4mmD	15°
6534-63-15SK	3.5mm	● 3.4mmD	15°
6534-63-30SK	3.5mm	● 3.4mmD	30°

Choose the convenience of a SMART PACK or select individual components à la carte





# LOCATOR® ABUTMENTS & COMPONENTS

## LOCATOR® Abutments Requires LOCATOR® Driver or Core Tool

Platform	1.0mmL	2.0mmL	3.0mmL	4.0mmL	5.0mmL
3.0mmD	6530-91N-L	6530-92N-L	6530-93N-L	6530-94N-L	6530-95N-L
3.4mmD	6534-91N-L	6534-92N-L	6534-93N-L	6534-94N-L	6534-95N-L



## LOCATOR® Abutment Components

Retention	Description	4 Pieces	10 Pieces
0.68kg	Xtra Light Ret Male Blue	1000-92B-L4	-
1.361kg	Light Ret Male Pink	1000-92P-L4	-
2.268kg	Regular Ret Male Clear	1000-92C-L4	-
0 lbs	Ext Range Male Gray	1000-92Z-L4	-
0.68kg	Ext Range Male Red	1000-92R-L4	-
0.907kg	Ext Range Male Orange	1000-92E-L4	-
1.814kg	Ext Range Male Green	1000-92G-L4	-
-	Black Processing Male	1000-93-L4	-
-	Processing Spacer	1000-100-L4	-
-	Repl Dent Cap Male Assembly	1000-91-L4	1000-91-L10



		1 Piece	2 Pieces	10 Pieces
Assorted	Male Processing Pkg	1000-98SI-L1	1000-98SI-L2	1000-98SI-L10
Assorted	Ext Range Male Processing Pkg		1000-98S-L2	1000-98S-L10



# LOCATOR® ABUTMENTS & COMPONENTS

## LOCATOR® Abutment Transfer, Analogs and Alignment Tools

Code	Description	
1000-94-L4	Impression Coping	4 Pieces
1000-95-L4	Abutment Analog 4mmD	4 Pieces
1000-97-L4	Abutment Parallel Post	4 Pieces
4500-26	Comfort Cap	2 Pieces
1000-99-L	Angle Measure Guide	
LDD	LOCATOR® Driver 29mm Handpiece	
LDDS	LOCATOR® Driver 23mm Handpiece	
LDT	LOCATOR® Square Driver 21mm Wrench	
LDTS	LOCATOR® Square Driver 15mm Wrench	
1000-96-L	LOCATOR® Core Tool	



## ZEST CHAIRSIDE®

Code	Description
09576	Recess Bur
09577	Undercut Bur
09578	Vent Hole Bur
09579	Trim Bur
05980	Polisher
09582	Denture Prep Polish Kit
09583	Grind Bur
09565	Attachment Processing Material (18ml)
09566	Attachment Processing Material 8gm (4ml)



## MULTI-UNIT ABUTMENTS & COMPONENTS

### Multi-Unit Abutments Requires 1.25mmD Hex Tool

Code	Collar Heights	Platform
6530-61	1.0mm	3.0mmD
6530-62	2.0mm	3.0mmD
6530-63	3.0mm	3.0mmD
6530-64	4.0mm	3.0mmD
6530-65	5.0mm	3.0mmD
6534-61N	1.0mm	3.4mmD
6534-62N	2.0mm	3.4mmD
6534-63N	3.0mm	3.4mmD
6534-64N	4.0mm	3.4mmD
6534-65N	5.0mm	3.4mmD

Includes Transfer & Comfort Cap



### Angled Multi-Unit Abutments Requires 1.25mmD Hex Tool

Platform	Collar Heights	15° Angled	30° Angled
3.0mmD	2.5mm	6530-62-15S	
3.0mmD	3.5mm	6530-63-15S	6530-63-30S
3.0mmD	4.5mm		6530-64-30S
3.4mmD	2.5mm	6534-62-15S	
3.4mmD	3.5mm	6534-63-15S	6534-63-30S
3.4mmD	4.5mm		6534-64-30S

Includes Fixation Abutment Screw, Transfer & Comfort Cap

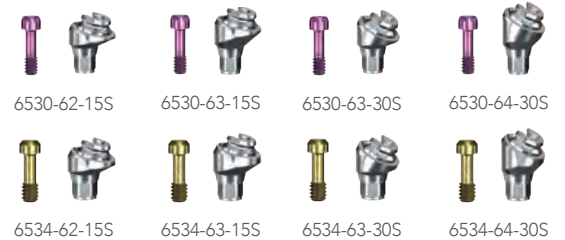

## MULTI-UNIT ABUTMENTS & COMPONENTS

### Replacement Tops for Angled Abutments Includes Transfer & Comfort Cap

Code	Description
1000-70S	Replacement Ball Top for Angled Base Short <small>[Requires 1.25mmD Hex Tool]</small>



1000-70S

### Multi-Unit Abutment Comfort Cap, Transfers & Analog Screws require 1.25mmD Hex Tool

Code	Platform	Description
1000-06D	5.0mmD	Titanium Analog for 3D Printed & Stone Models
1000-62	5.0mmD	Open-Tray Transfer plus Fixation Screw
1000-63	5.0mmD	Closed-Tray Transfer plus Fixation Screw
1000-68	5.0mmD	Plastic Abutment Transfer - 2 Pieces
4000-13	5.0mmD	Plastic Comfort Cap - 2 Pieces
1000-14	-	Replacement Open-Tray Fixation Screw - 2 Pieces
1000-15	-	Replacement Closed-Tray Fixation Screw - 2 Pieces
1000-09P	-	Multi-Unit Scan Adapter



1000-06D



1000-62



1000-63



1000-68



4000-13



1000-09P

### Multi-Unit Abutment Components

Code	Platform	Description
1000-64	5.0mmD	Gold Coping
1000-65	5.0mmD	Titanium Coping
1000-66	5.0mmD	Plastic Coping
1000-67	5.0mmD	Gold & Plastic Coping
1000-69	5.0mmD	Titanium Temporary Coping
1000-05	-	Coping Fixation Screw - 2 Pieces
1000-25	-	Dual-Grip™ Coping Fixation Screw - 2 Pieces
1000-69BP	-	SMARTbase Cylinder for all Multi-Unit Abutments (pink)
1000-69BG	-	SMARTbase Cylinder for all Multi-Unit Abutments (gold)

Includes Fixation Screw [1000-05], optional Dual-Grip™ Fixation Screw [1000-25]



1000-05

1000-25

1000-64

1000-65

1000-66

1000-67

1000-69



1000-69BP



1000-69BG

# INTERACTIVE INSTRUMENTS

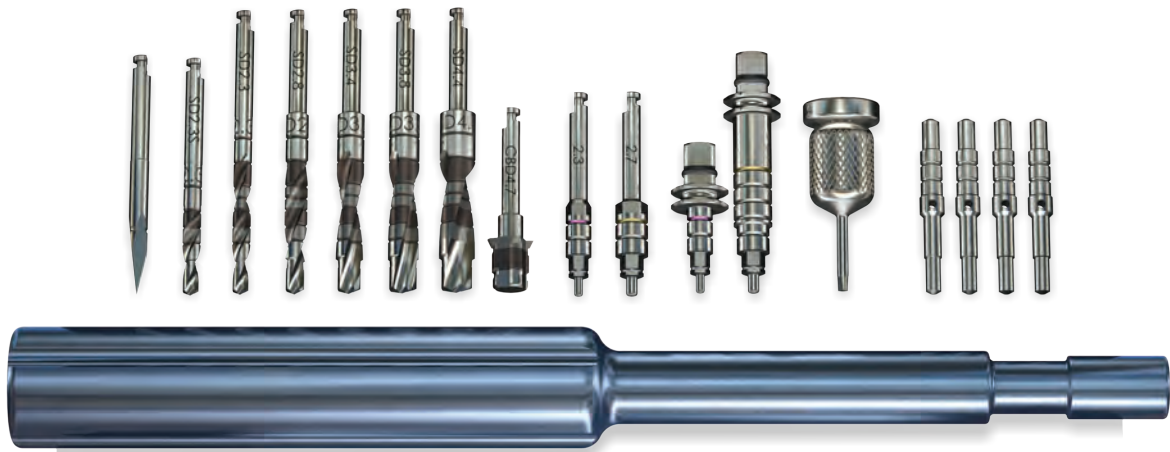

Surgical & Prosthetics

Drills

Surgical Trays

# SURGICAL & PROSTHETIC INSTRUMENTS

## Surgical Trays

Code	Description
IST	Empty Surgical Kit for InterActive Implants
IBST	Basic Surgical Kit for InterActive Implants
ICST	Complete Surgical Kit for InterActive Implants



## Guided Surgery Handle Kit & Accessories

Code	Description
G-HK	Handle Kit (Includes: guide handles, spacers & spacer tool)
DGDE	Drill Guide Drill Extender
SD2.3L	Pilot Drill with depth markings of 22, 25 and 28mm
SD2.8L	Pilot Drill with depth markings of 22, 25 and 28mm
G-Sleeve	Guided Template Sleeve (small)
G-Sleeve-L	Guided Template Sleeve (large)
GS	Small Handle Drill Guide Spacer
GS-2.3	Guided Surgery Handle Insert 2.3mmD
GS-2.8	Guided Surgery Handle Insert 2.8mmD
GS-3.4	Guided Surgery Handle Insert 3.4mmD
GS-3.8	Guided Surgery Handle Insert 3.8mmD
GS-4.4	Guided Surgery Handle Insert 4.4mmD
GS-4.8	Guided Surgery Handle Insert 4.8mmD
GS-5.1	Guided Surgery Handle Insert 5.1mmD
GS-5.4	Guided Surgery Handle Insert 5.4mmD

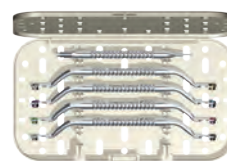

## Tapered Hex Tools

Code	Description
THT1.25	1.25mmD Tapered Hex Tool-Long
THT1.25S	1.25mmD Tapered Hex Tool-Short

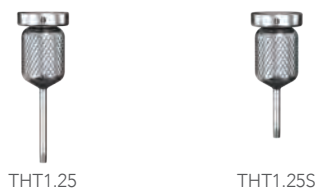

## Straight Hex Tools Square connection for use with Ratchet or Torque Wrench

Code	Description
HT1.25L	1.25mmD Straight Hex Tool Extra Long (For use with Torque Wrench)
HT1.25	1.25mmD Straight Hex Tool Long (For use with Torque Wrench)
HT1.25S	1.25mmD Straight Hex Tool Short (For use with Torque Wrench)
HT2.3LG	2.3mmD Straight Hex Tool Long
HT2.3SG	2.3mmD Straight Hex Tool Short
HT2.7LG	2.7mmD Straight Hex Tool Long
HT2.7SG	2.7mmD Straight Hex Tool Short
AXS3.0	3.0mmD Abutment Removal Screw (For use with Straight 1.25mmD Hex Tools)
AXS3.4	3.4mmD Abutment Removal Screw (For use with Straight 1.25mmD Hex Tools)



# SURGICAL & PROSTHETIC INSTRUMENTS

## Hex Tools Latch head connection for use with Surgical Motor

Code	Description
HD1.25	1.25mmD Hex Drill
HD2.3SG	2.3mmD Hex Drill
HD2.7SG	2.7mmD Hex Drill



## Ancillary Instruments

Code	Description
R	Ratchet
TW	Torque Wrench
TW30	30Ncm Torque Wrench
TWM	Multi-Setting Torque Wrench (15, 20, 25, 30, 35, 40, 45, 50 & 60Ncm)
SSHM	Stainless Steel Handle Multiple
FMD	Fixture Mount Drill
PAR	Paralleling Tool 2.8/2.3
RB-06	Round Bur #6
LDRILL	Locator Drill
DGDE	Drill Guide Drill Extender
ABH	Analog Holder
LDD	LOCATOR® Driver 29mm Handpiece
LDDS	LOCATOR® Driver 23mm Handpiece
LDT	LOCATOR® Square Driver 21mm Wrench
LDTs	LOCATOR® Square Driver 15mm Wrench
1000-96-L	LOCATOR® Core Tool
PK-E	Prosthetic Kit Tray (empty)
PK-5	Complete Prosthetic Kit Tray (includes Torque Wrench with adapter and three 1.25 hex drivers)

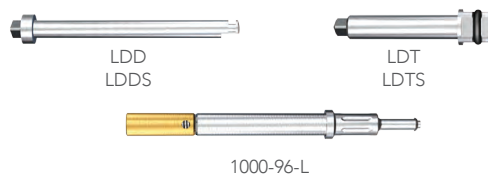

# SURGICAL DRILLS

## 3.2mmD Implants

Code	Description
SD2.3	2.3/2.0mmD Step Drill with 6-16 markings
SD2.3S	2.3/2.0mmD Step Drill with 6-10 markings
SD2.8	2.8/2.3mmD Step Drill with 6-16 markings
SD2.8S	2.8/2.3mmD Step Drill with 6-10 markings
CBD3.2	Cortical Bone Drill for 3.2mmD Implants

SD2.3



SD2.3S



SD2.8



SD2.8S



CBD3.2



## 3.7mmD Implants

Code	Description
SD3.4	3.4/2.8mmD Step Drill with 6-16 markings
SD3.4S	3.4/2.8mmD Step Drill with 6-10 markings
CBD3.7	Cortical Bone Drill for 3.7mmD Implants

SD3.4



SD3.4S



CBD3.7



## 4.3mmD Implants

Code	Description
SD3.8	3.8/3.4mmD Step Drill with 6-16 markings
SD3.8S	3.8/3.4mmD Step Drill with 6-10 markings
CBD4.2	Cortical Bone Drill for 4.3mmD Implants

SD3.8



SD3.8S



CBD4.2



## 5.0mmD Implants

Code	Description
SD4.4	4.4/3.8mmD Step Drill with 6-16 markings
SD4.4S	4.4/3.8mmD Step Drill with 6-10 markings
CBD4.7	Cortical Bone Drill for 5.0mmD Implants

SD4.4



SD4.4S



CBD4.7





# DRILL SEQUENCE

## 3.2mm Diameter

3.0/3.2



Soft Bone Final    Dense Bone Final    Optional  
Crestal Bone Drills\*



SD2.3  
2.3/2.0mmD



SD2.8  
2.8/2.3mmD



CBD3.2

## 3.7mm Diameter

3.0/3.7



SD2.3  
2.3/2.0mmD

Soft Bone Final    Dense Bone Final    Optional  
Crestal Bone Drills\*



SD2.8  
2.8/2.3mmD



SD3.4  
3.4/2.8mmD



CBD3.7

## 4.3mm Diameter

3.4/4.3



SD2.3  
2.3/2.0mmD

Optional



SD2.8  
2.8/2.3mmD

Soft Bone Final    Dense Bone Final    Optional  
Crestal Bone Drills\*



SD3.4  
3.4/2.8mmD



SD3.8  
3.8/3.4mmD



CBD4.2

## 5.0mm Diameter

3.4/5.0



SD2.3  
2.3/2.0mmD

Optional



SD2.8  
2.8/2.3mmD



SD3.4  
3.4/2.8mmD

Soft Bone Final    Dense Bone Final    Optional  
Crestal Bone Drills\*



SD3.8  
3.8/3.4mmD



SD4.4  
4.4/3.8mmD



CBD4.7

\*To be used in dense bone

## SURGICAL TRAYS



Lid



Inside



Empty Tray

Code	Description	Complete Kit	Basic Kit
IST	Empty Surgical Tray	X	X
SD2.3	2.3/2.0mmD Step Drill-Long	X	X
SD2.3S	2.3/2.0mmD Step Drill-Short	X	
SD2.8	2.8/2.3mmD Step Drill-Long	X	X
SD2.8S	2.8/2.3mmD Step Drill-Short	X	
CBD3.2	3.2mmD Cortical Drill	X	
SD3.4	3.4/2.8mmD Step Drill-Long	X	X
SD3.4S	3.4/2.8mmD Step Drill-Short	X	
CBD3.7	3.7mmD Cortical Drill	X	
SD3.8	3.8/3.4mmD Step Drill-Long	X	X
SD3.8S	3.8/3.4mmD Step Drill-Short	X	
CBD4.2	4.2mmD Cortical Drill	X	
SD4.4	4.4/3.8mmD Step Drill-Long	X	X
SD4.4S	4.4/3.8mmD Step Drill-Short	X	
CBD4.7	4.7mmD Cortical Drill	X	
<b>Hex Tools</b>			
THT1.25	1.25mmD Tapered Hex Tool-Long	X	X
THT1.25S	1.25mmD Tapered Hex Tool-Short	X	
HT1.25	1.25mmD Straight Hex Tool-Long	X	X
HT1.25S	1.25mmD Straight Hex Tool-Short	X	
HT2.3	2.3mmD Hex Tool-Long	X	X
HT2.3S	2.3mmD Hex Tool-Short	X	
HT2.7	2.7mmD Hex Tool-Long	X	X
HT2.7S	2.7mmD Hex Tool-Short	X	
HD1.25	1.25mmD Hex Drill	X	X
HD2.3	2.3mmD Hex Drill	X	
HD2.7	2.7mmD Hex Drill	X	
<b>Ancillary Instrumentation</b>			
FMD	Fixture Mount Drill	X	
LDRILL	Locator Drill	X	X
DE	Drill Extender	X	X
R	Ratchet	X	X
PAR (x4)	Paralleling Tool 2.8/2.3	X	X





Implant Direct provides a complete line of dental care products and services tailored to maximize clinical efficiency and patient care over the life of your practice. We offer high-quality dental implant products and a broad range of surgical, prosthetic and regenerative solutions in over 40 countries worldwide.

All our implants are manufactured in the United States. We continue to test and inspect our products to ensure they meet the highest quality and testing standards worldwide so you can practice in confidence.